

---

## 3V-28V $V_{in}$ , 300mA, 2.4 $\mu$ A $I_Q$ , Low-Dropout Regulator with PG Feature

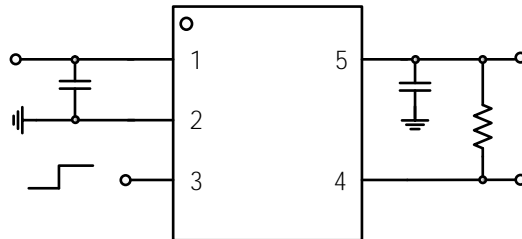

---

|  |  |  |  |  |
|--|--|--|--|--|
|  |  |  |  |  |
|  |  |  |  |  |
|  |  |  |  |  |

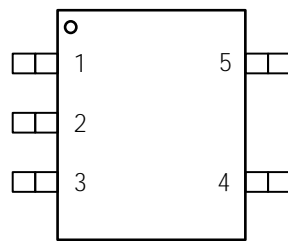

|  |  |  |
|--|--|--|
|  |  |  |
|  |  |  |
|  |  |  |
|  |  |  |
|  |  |  |
|  |  |  |

---







(1)

(2)



(1)

(2)





|  |  |  |  |  |
|--|--|--|--|--|
|  |  |  |  |  |
|--|--|--|--|--|



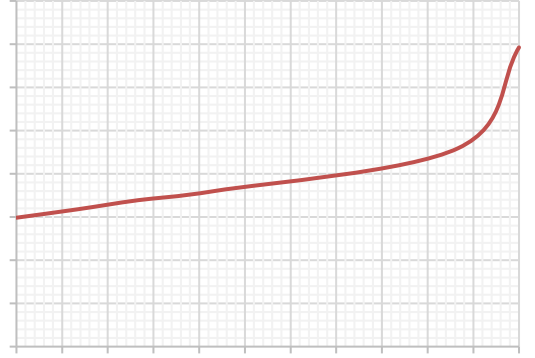
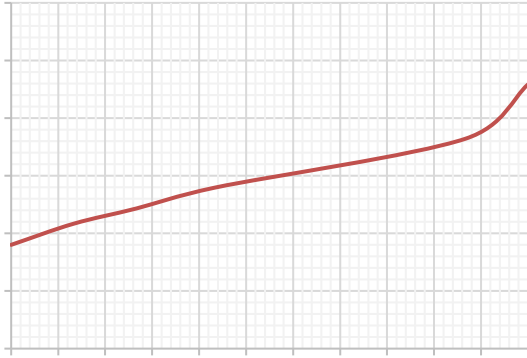
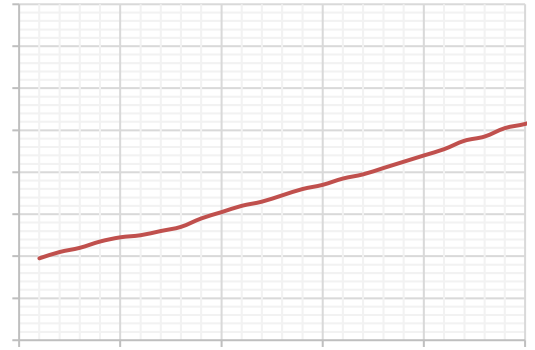
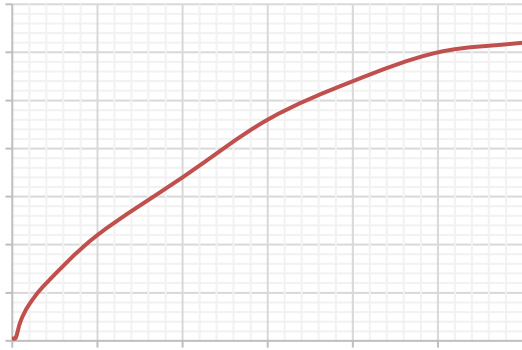

°C

°C

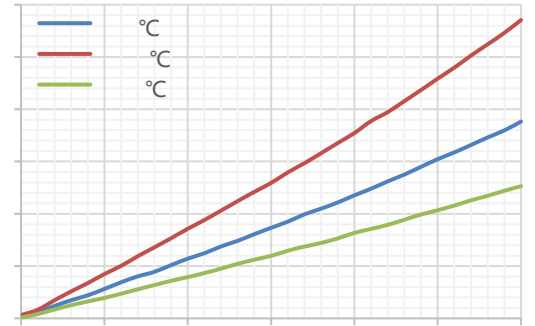



°C



°C

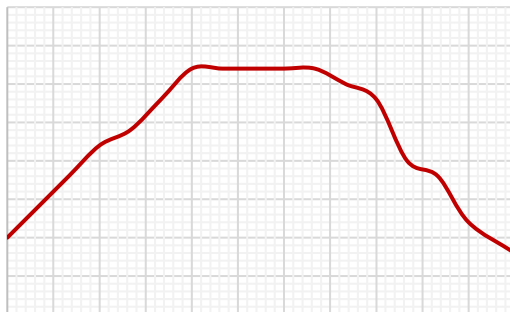
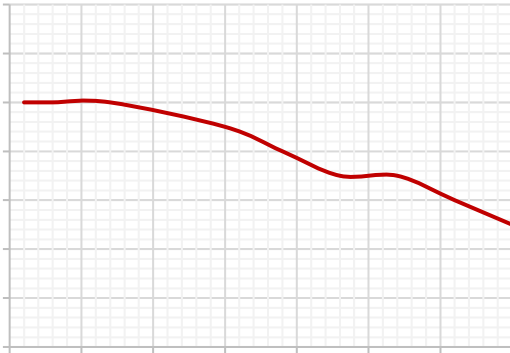

°C



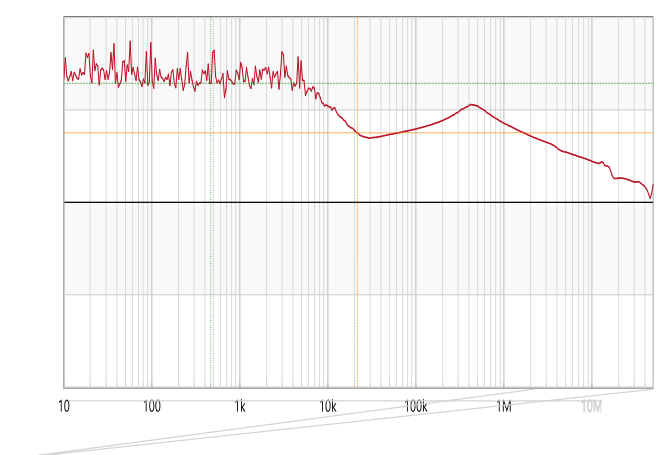
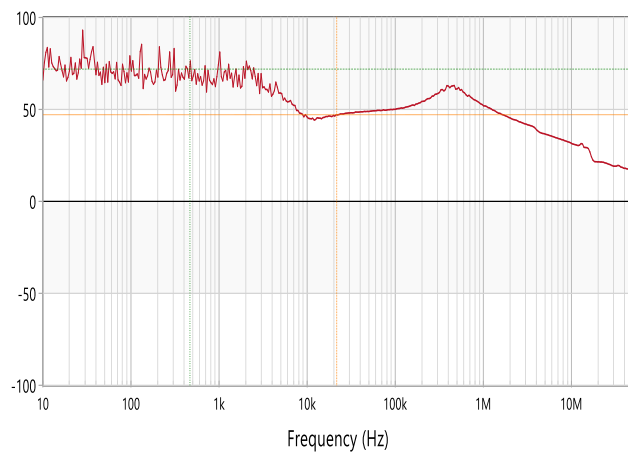
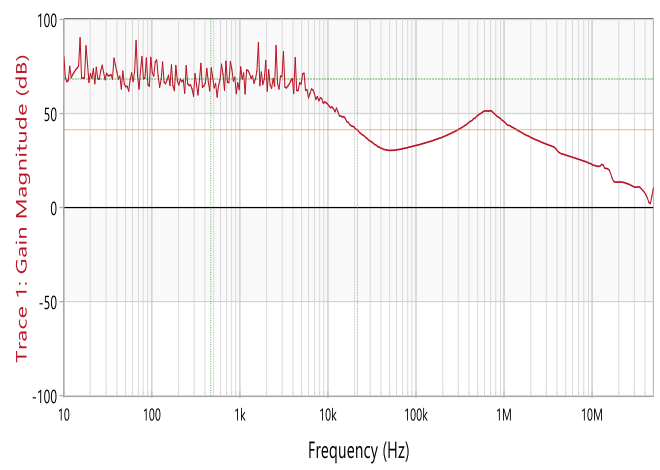
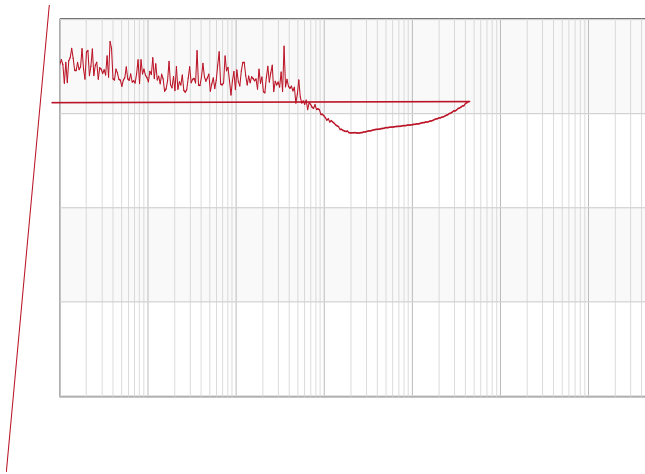
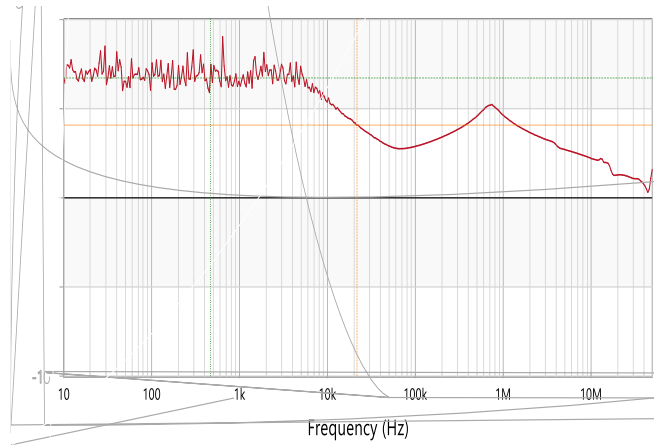
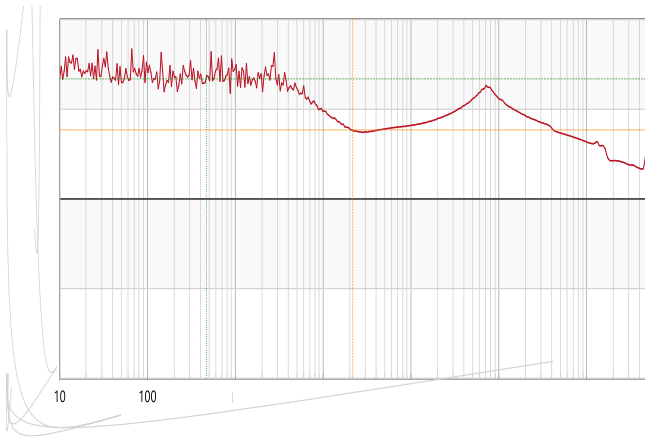

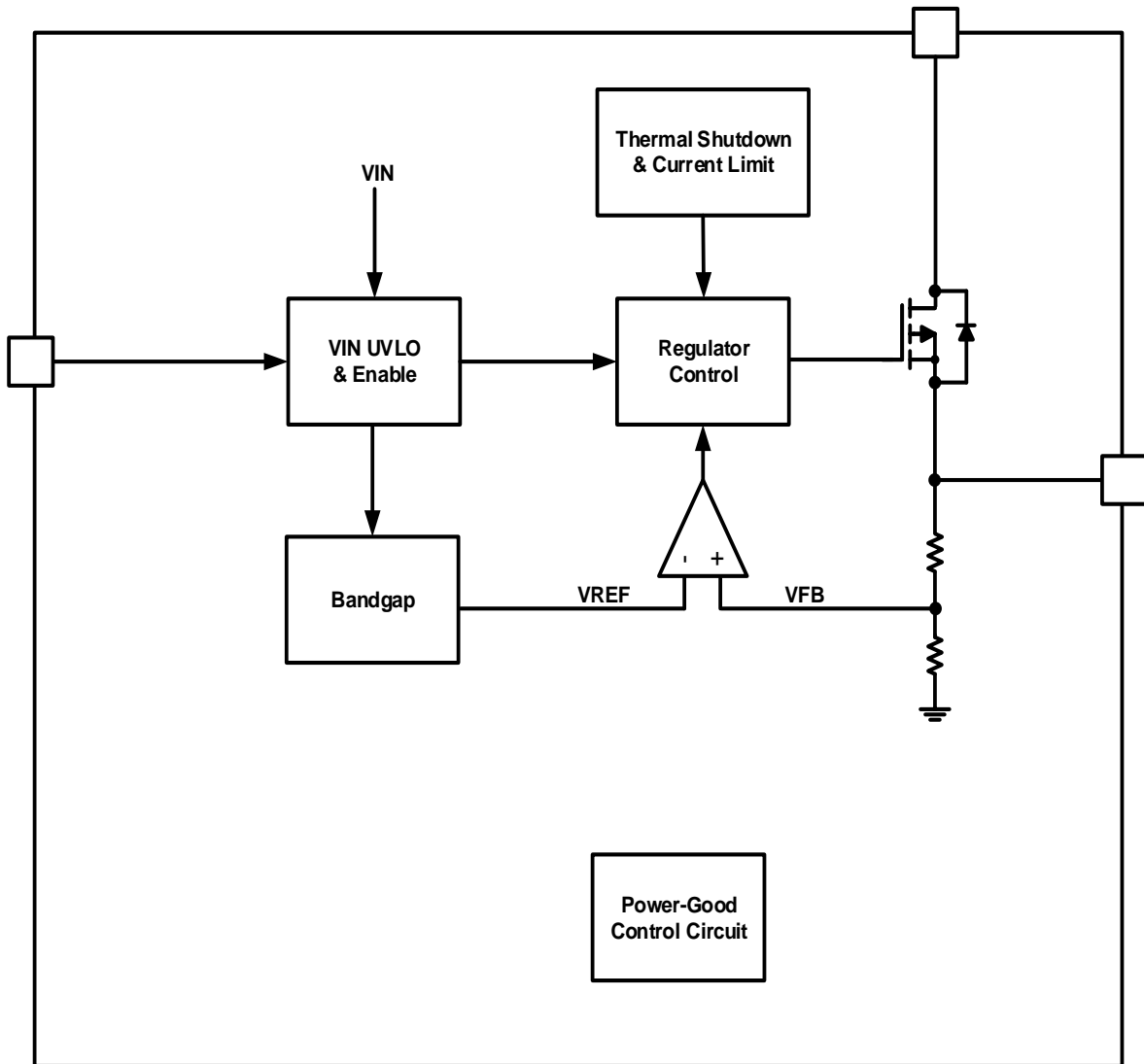

\_\_\_\_\_

\_\_\_\_\_

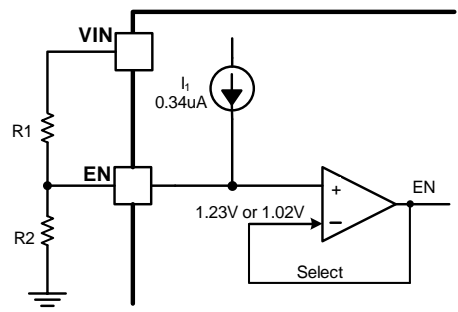

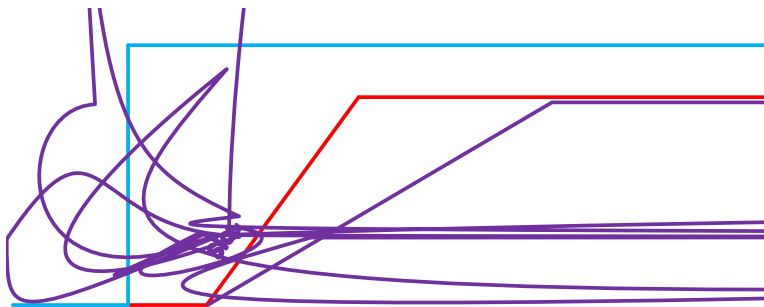
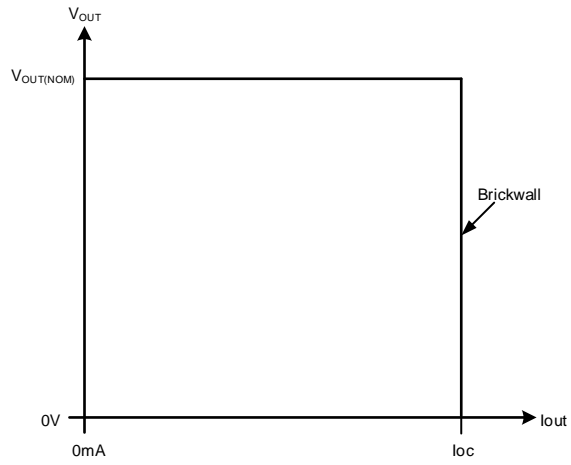

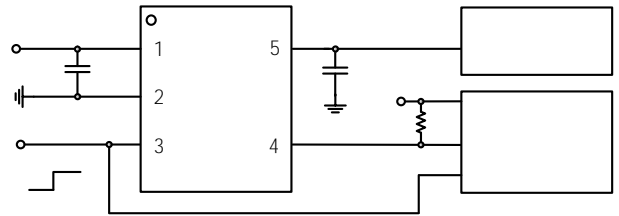
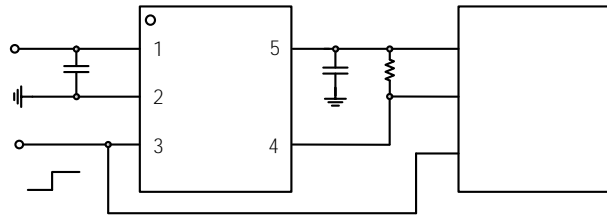

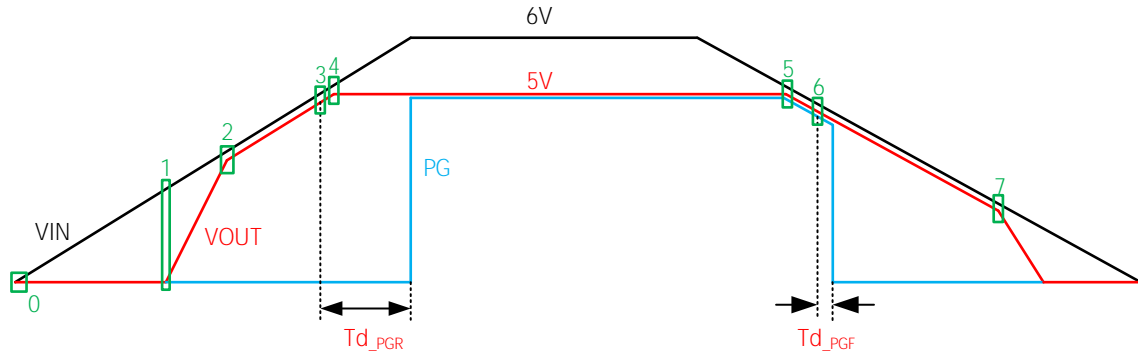

---





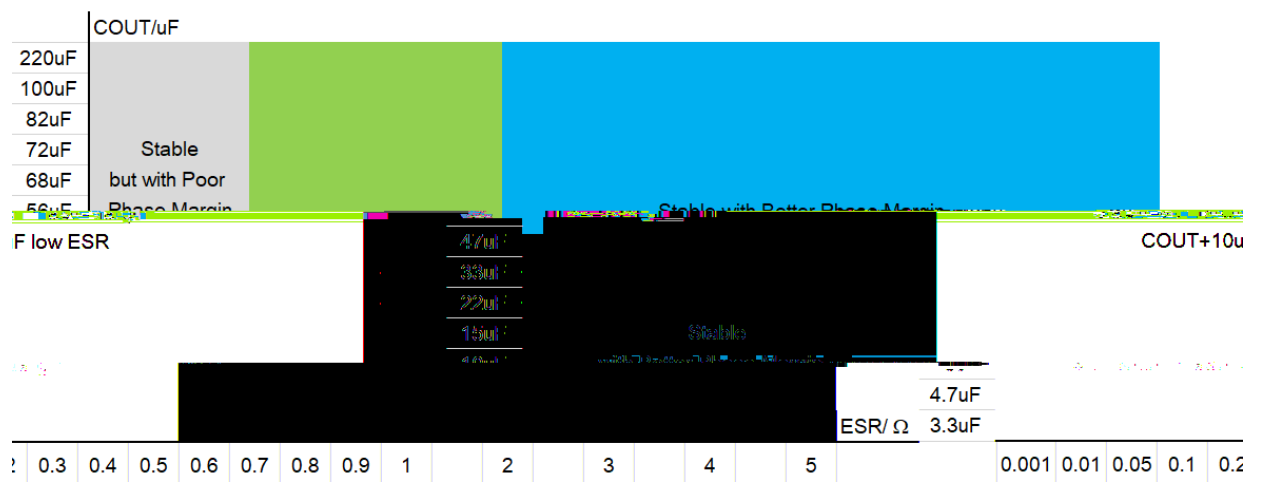

---

PHWKÍ:A... DUJ a"ëó™! 5U 1 FDOFX

°C



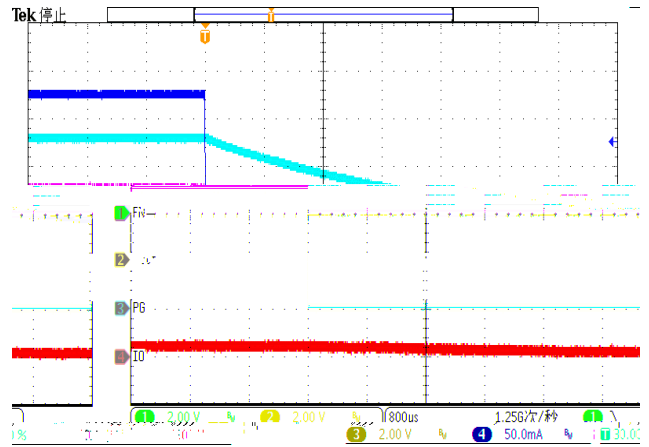
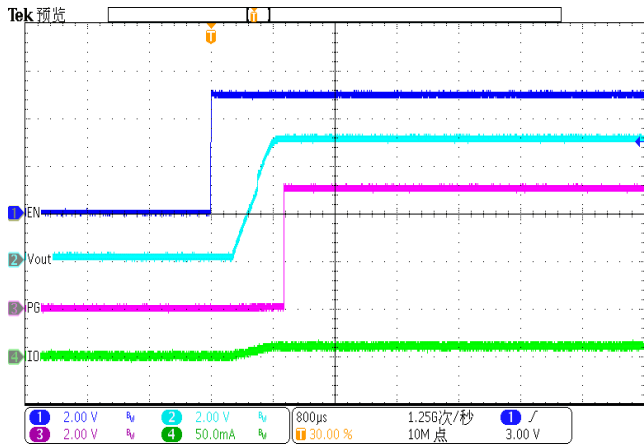
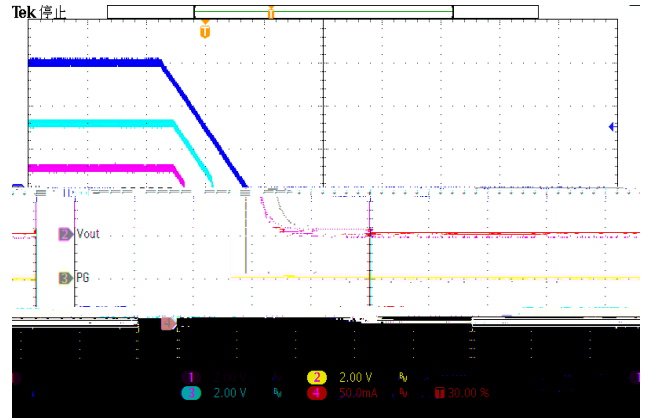
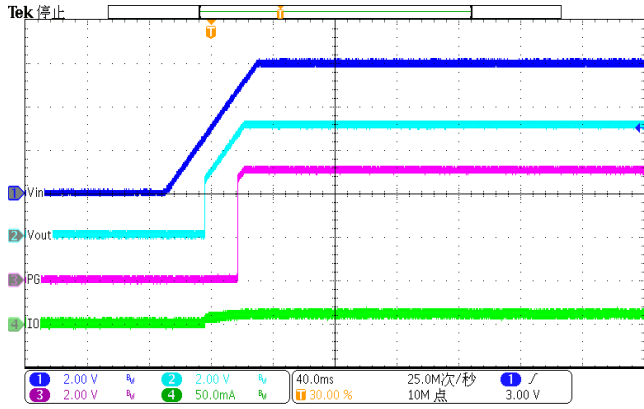
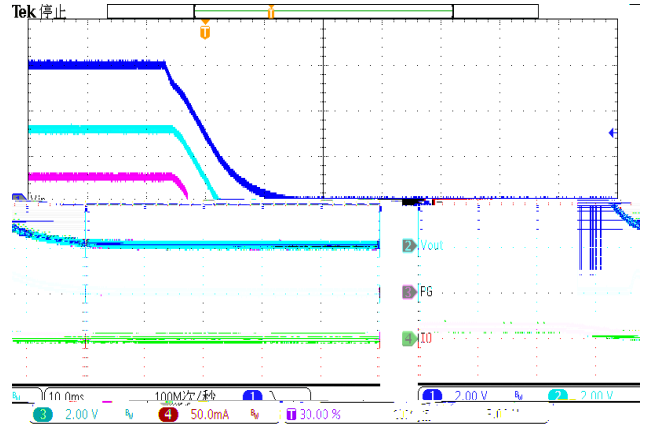
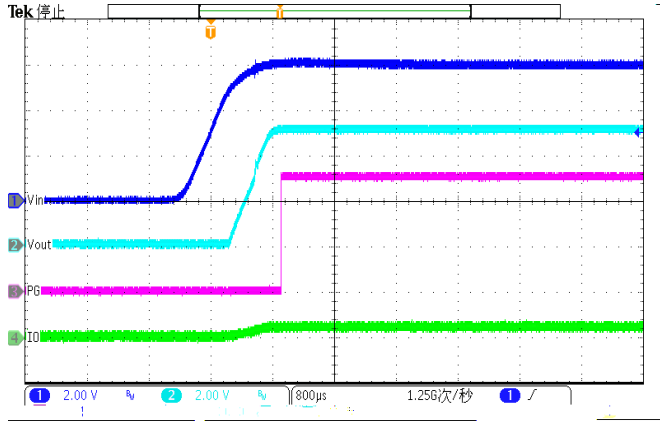

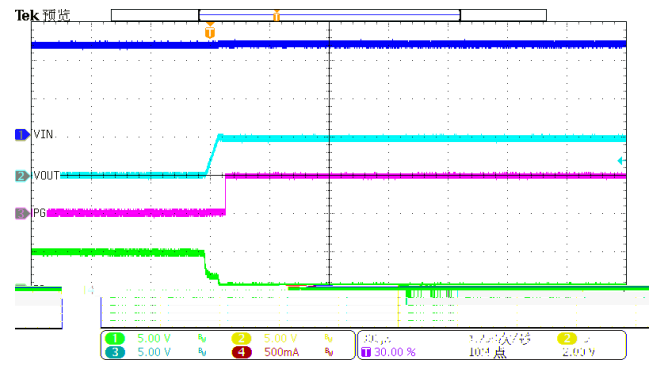
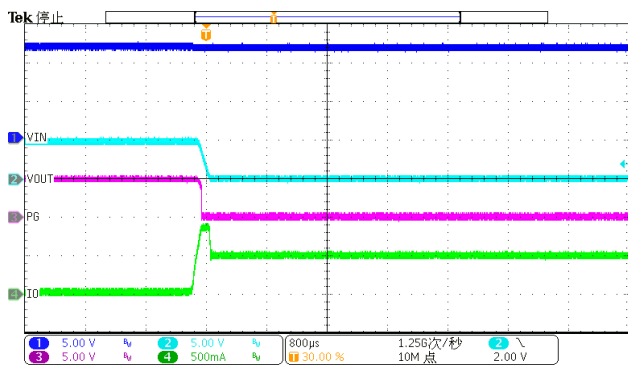
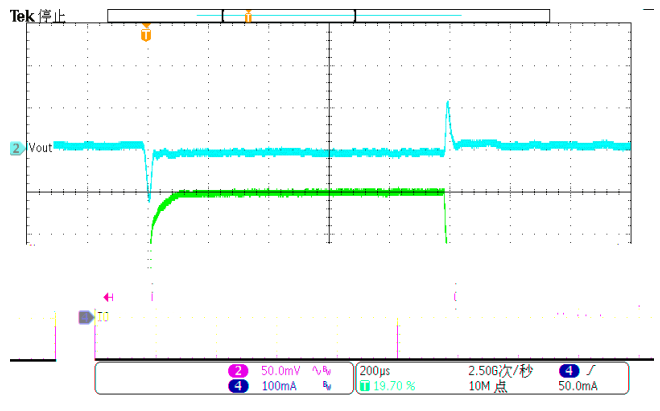
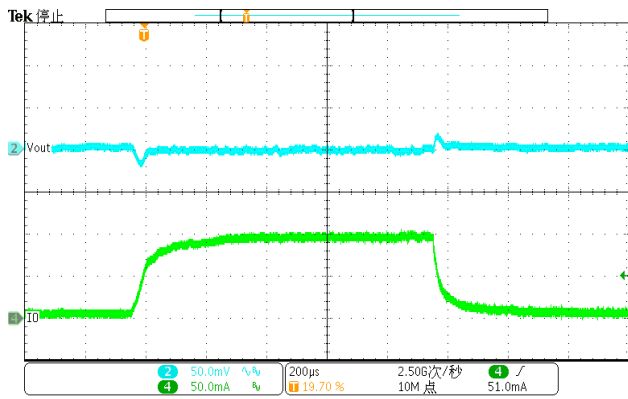
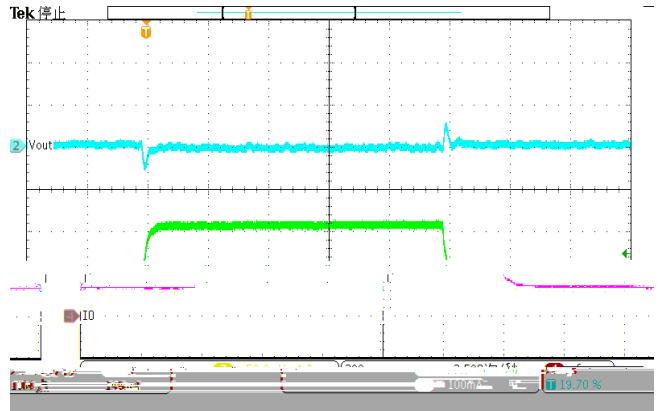
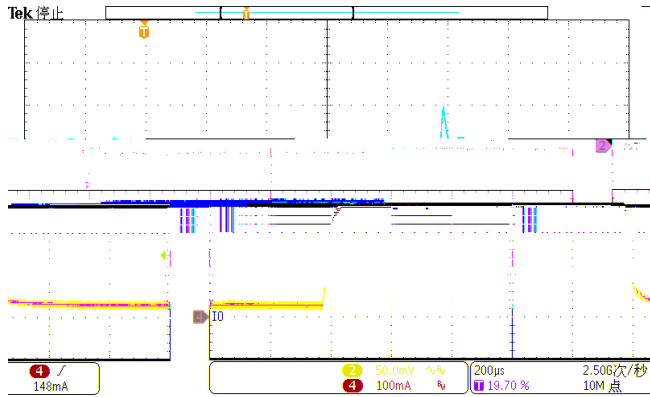



---

|  |  |  |  |
|--|--|--|--|
|  |  |  |  |
|  |  |  |  |

