

3V-40V Vin, 300mA, 2.4uA Iq, Low-Dropout Regulator with PG Feature

.1-0
 0 1- % &
 0-- + .1-0) .-
 00 // - +
 / # .1-0 +
 0# % & 1+
 . #) . +) / +) 0) 1 # & 1+
 % &
 / ± .
 1- . - ± /
 / #
 / 0- . - -
 1 - / - -
 0# // -
 - + - .
 -
 % &
 % &
 / 0 , // , 0 0 ,
 0 0 , // 0 1

+

. +
. +
. +

.1-0 -	+	/ /	-)0---
.1-0 00	00	/ /	00)0---
.1-0 -	+	/ /	-)0---
.1-0 00	00	/ /	00)0---
.1-0 -	+	0 0	-)1---
.1-0 00	00	0 0	00)1---
.1-0 -	+	/0	-)0---
.1-0 00	00	/0	00)0---
.1-0 -	+	0 0	-) ---
.1-0 00	00	0 0	00) ---
.1-0 -	+	//01	-)/ --
.1-0 00	00	//01	00)/ --

/

+ +

/-//

→ +

.1-0



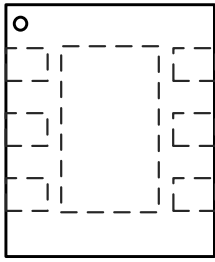

//

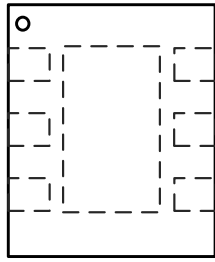

//

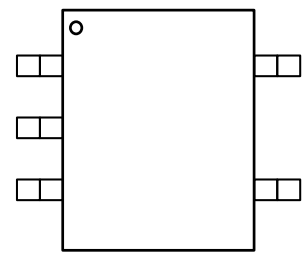

/0

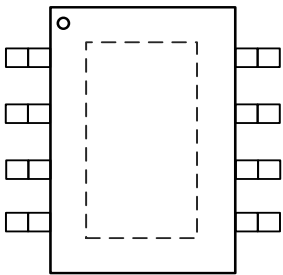

00

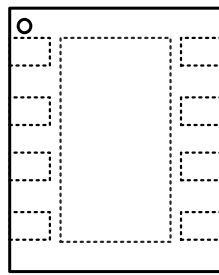

00

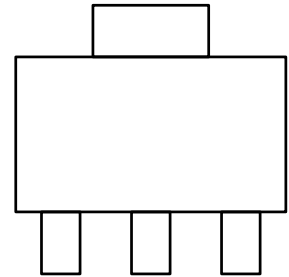

//01

	
	/	/	/		/		
	0	0	1	0	1	/)1	+
	1	1)	0)))	/)1	0))		

		0	1-	
		. #		
		-		
		-		
		/ #		
		0-0	//-	
		- + - .		
		1-	. -	

%&

		- 0	1	
		- 0	+	
		- 0		
		- 0	+	
%&		1-	. -	
			. -	

(1)

+

(2)

+

+

. -

+

+

) % &	--. /-.1	0	(0
/-.1) % &	--/	.	(.



		- + % &	.	/
	%&		.	-
			.	

- (1)) . - - % & . +
- (2) +

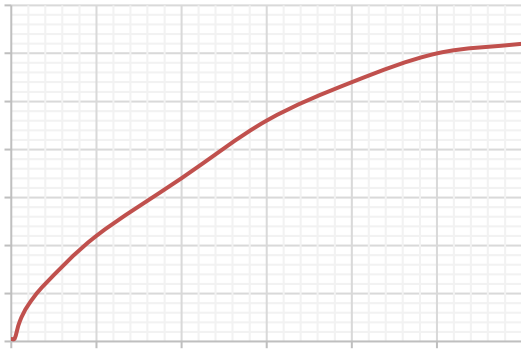

. +

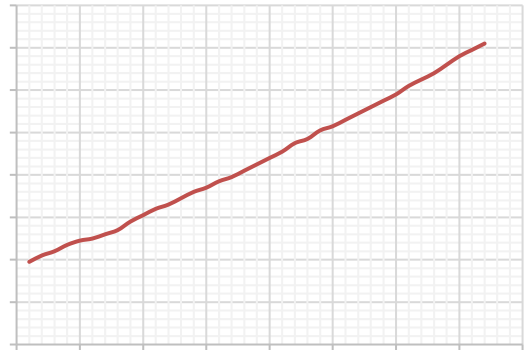

/ +)

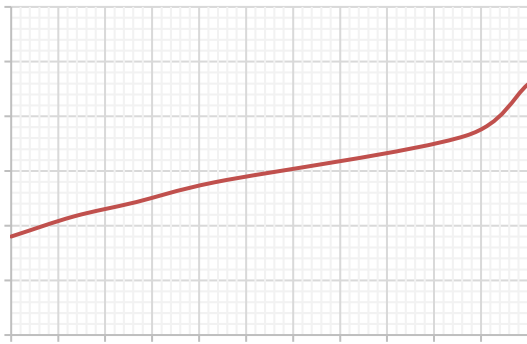

°C

0+

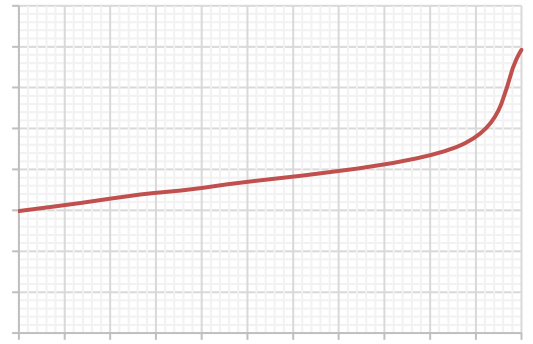

°C

1+

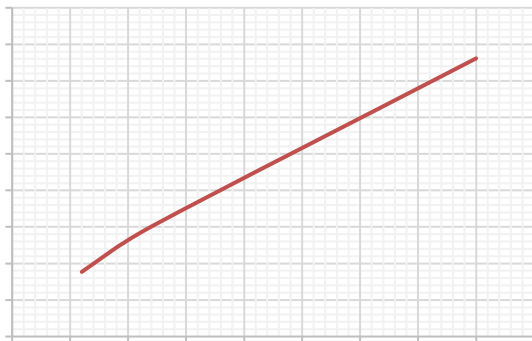

+

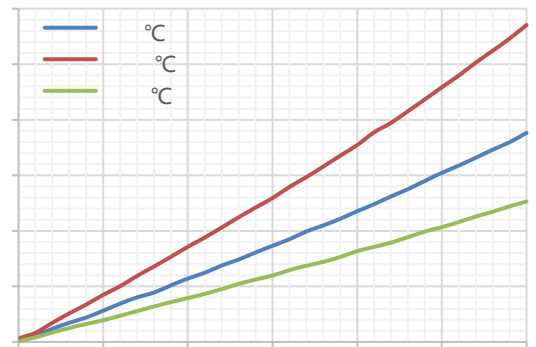

+

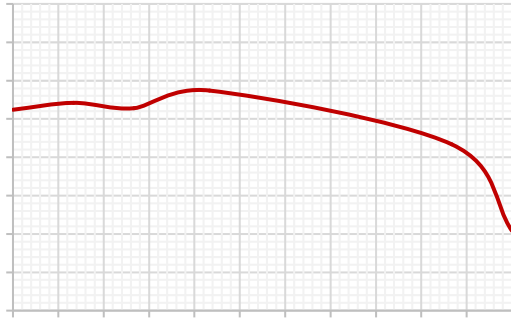

°C

+



°C

+

0θ

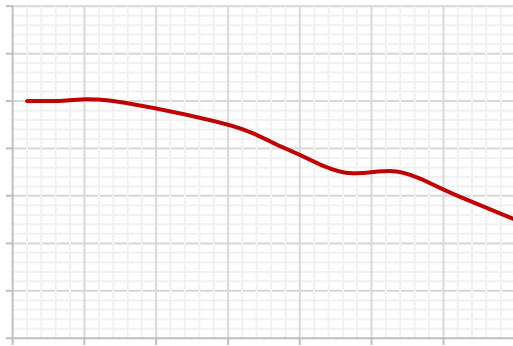

+

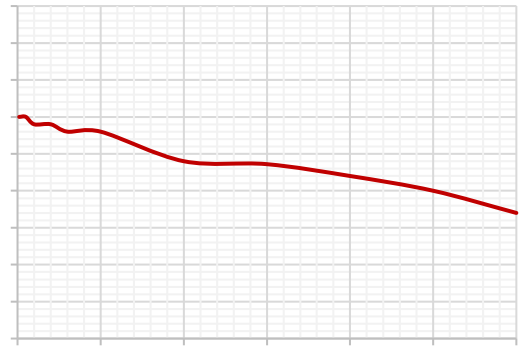

.- +



°C

.. +

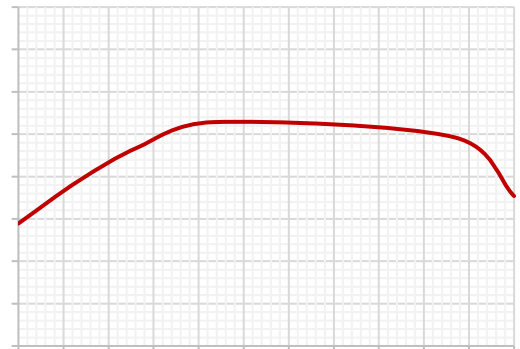

°C

./ +

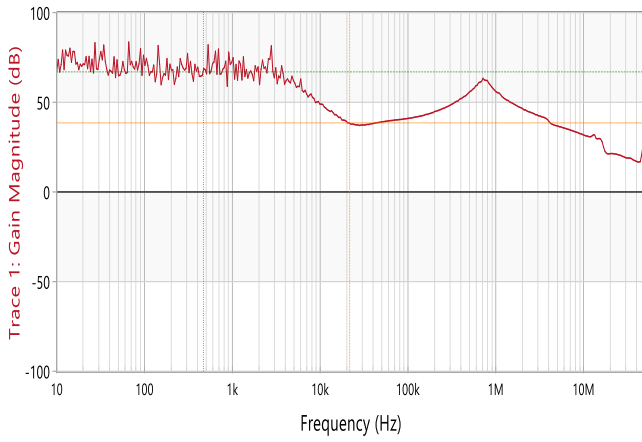

. 0+ . -) 1+

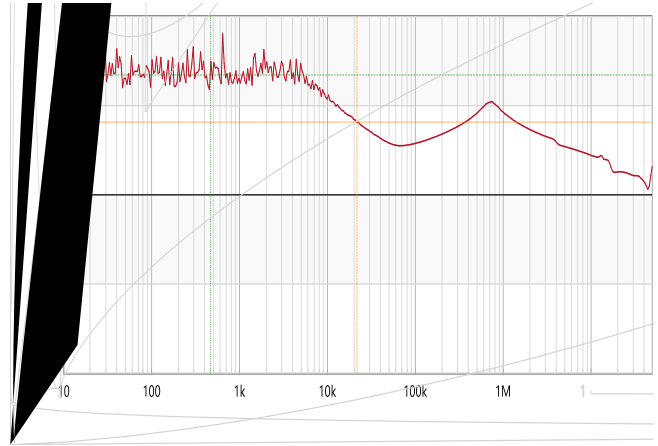

. 1+ . --) 1+

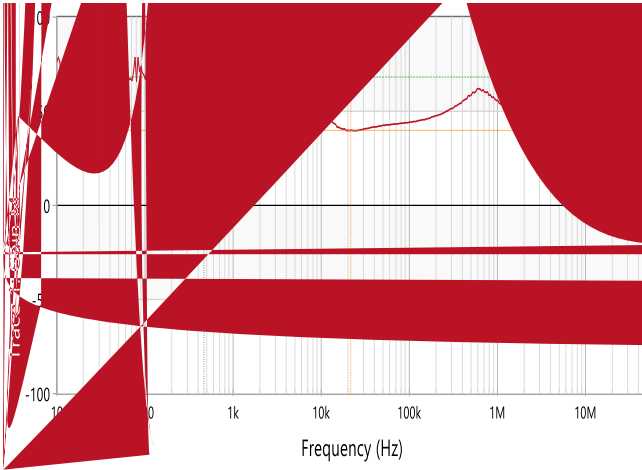

. + . -) . -

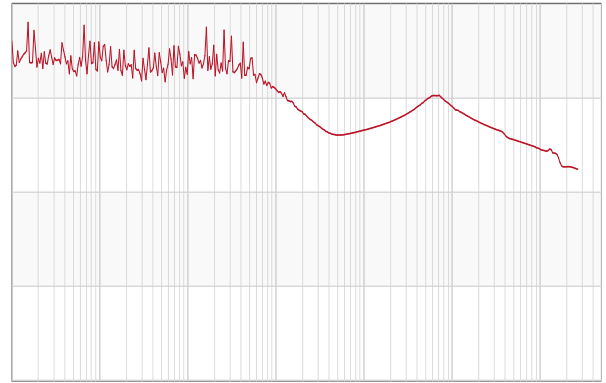

. + . --) . -

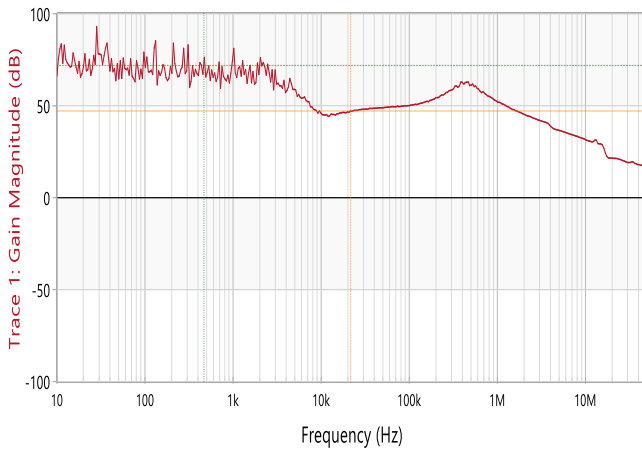

. + . -) //

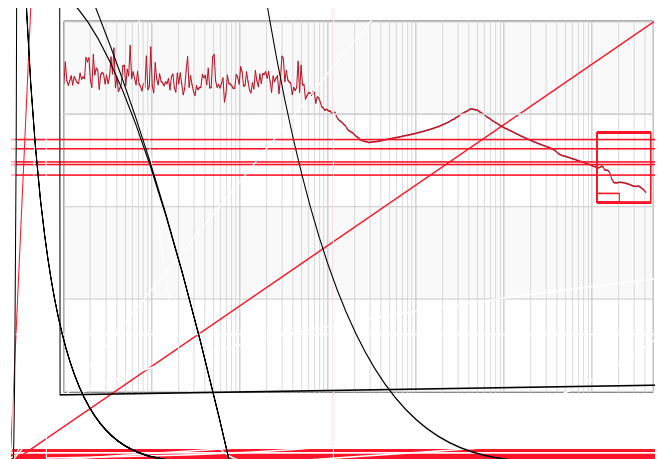

. + . --) //

. - + + /-// → +

. 1-0

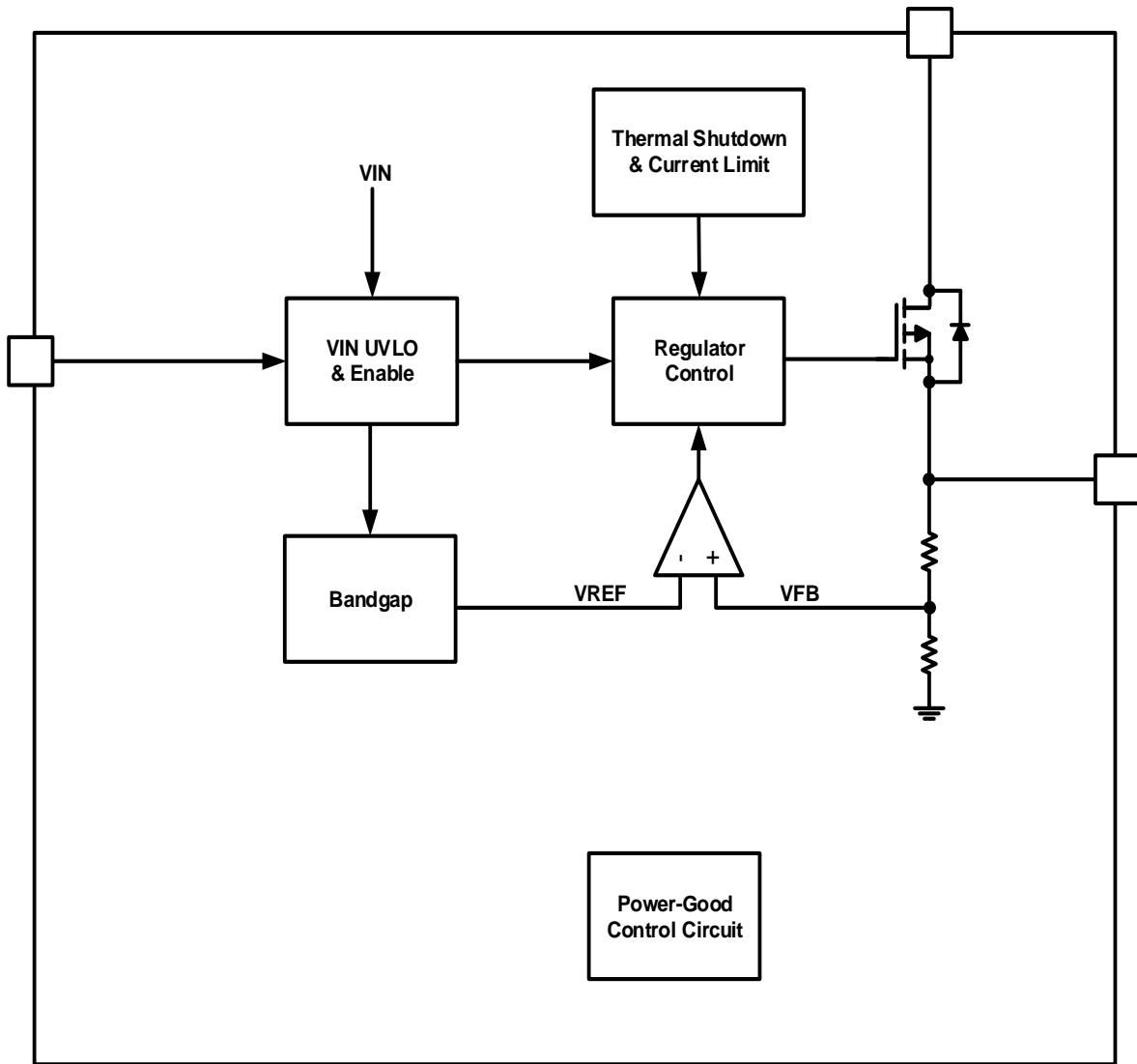

. +

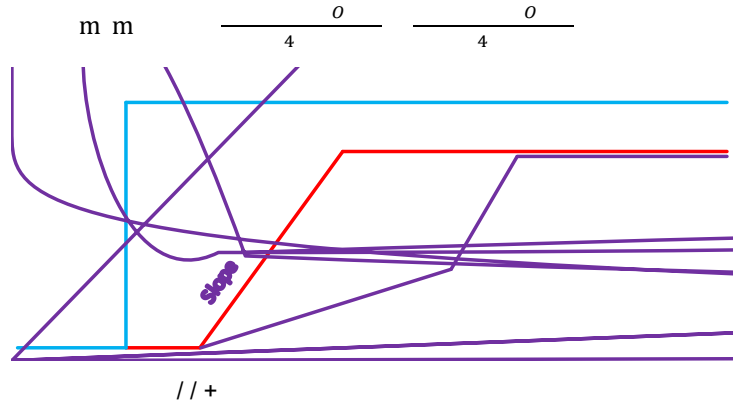

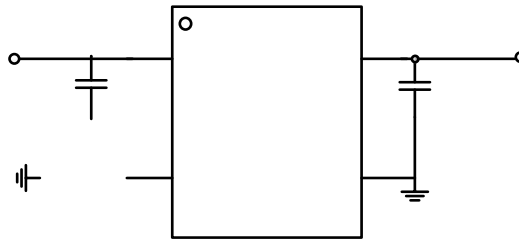

/ + .1-0

	. /)0 1-
	0∅
	0--
% &	0∅ //) .-
% &	/ #) .-
% . &	.-

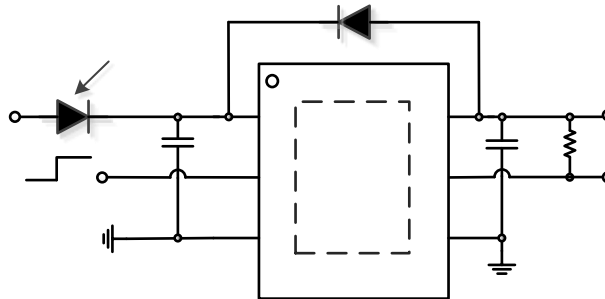

/ + .1-0

	. /)0 1-
	0∅
	0--
% &	0∅ //) .-
% &	/ #) .-
% . &	.-

) +) +)
) // - +)
 +)
 +)

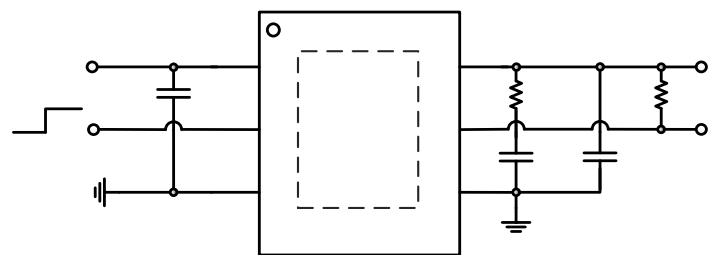

/ + .1-0

	. /) 0 1-
	0-0
	0--
% . &	0-0 // - - +
% / &	. -
% &	/ #) . -
% . &	. -

+ / + - +
+
) .1-0
0-0 +

+ + /-// + +

.1-0

)) +) +)
) + . -)
 +
 + 1+) 1
 +
 I G HNM HNM G G %&
 +
 +
 c I c o %&

.1-0)
) +) +)
)
 /).) - 0- +

		°C	°C
/ /	/ 0/	/ +-	/ +
0 0	/ +0	/ #1	. #
/ 0	. #	. +	.. #
0 0	/ #/	/ +	-
// 0 1	0+	/ +.	1

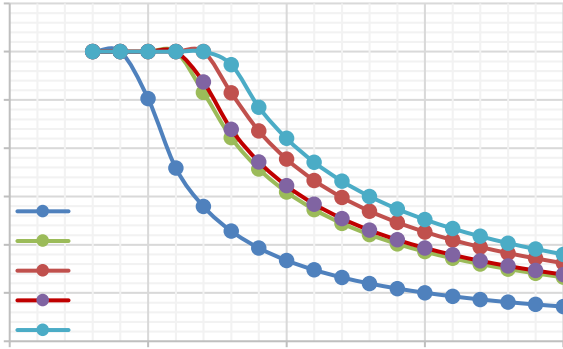

0-+))

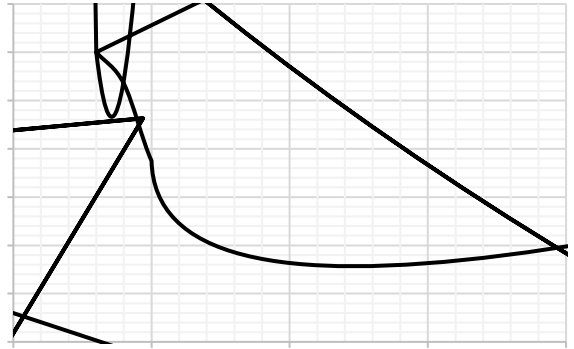

0.+ 00))

0/+) / /) . -°C

00+ / /) . -°C)

01+) / 0) . -°C

0 + / 0) . -°C)

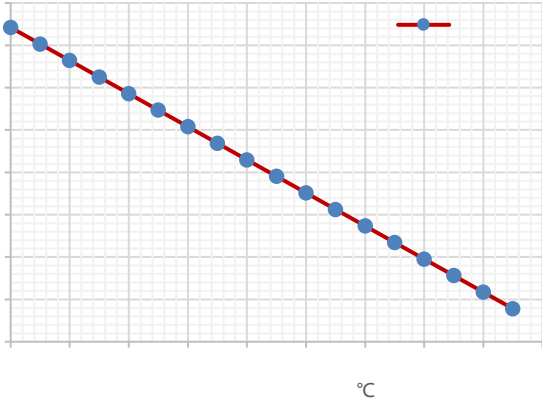

0 +) 0 0) . -°C

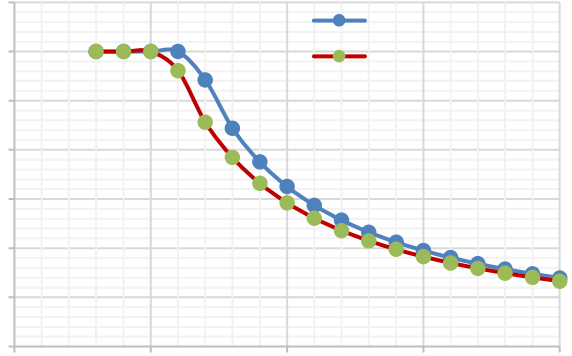

0 +) 0 0) . -°C

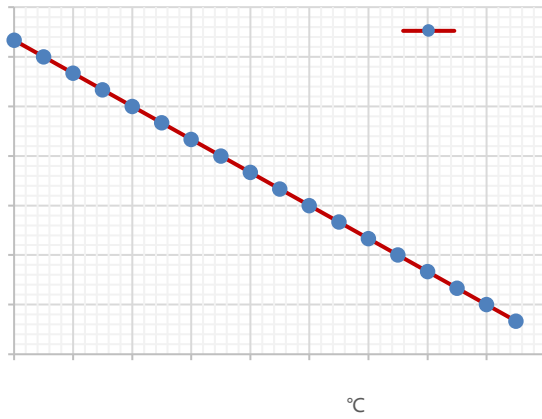

0 +) 0 0) . -°C

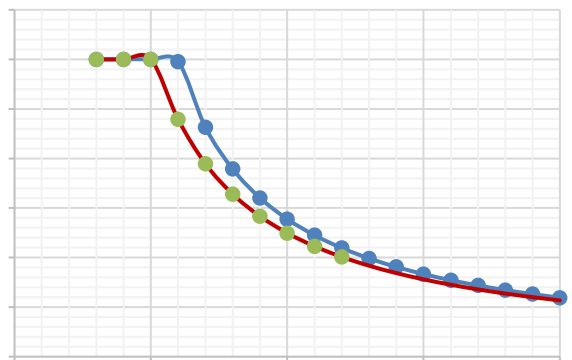

0 +) 0 0) . -°C

1- +) //01) . -°C

1. +) //01) . -°C

(.)

1 / + % . - &

10+ % . - &

11 % . - &

1 . % . - &

1 + % . - &

(. .)

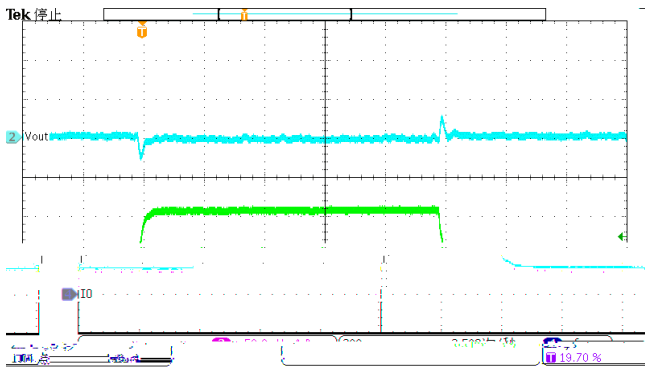

1 +
% // &

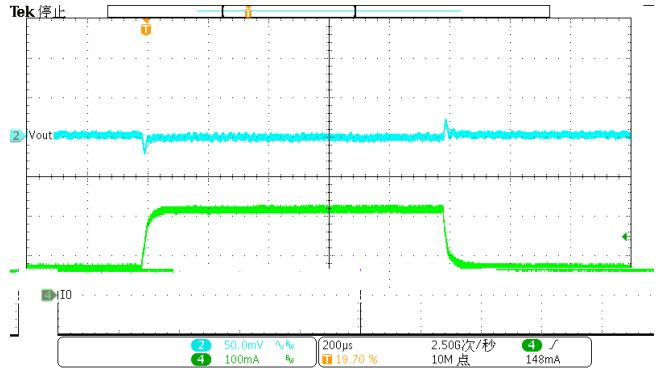

1 +
% // & 0-0

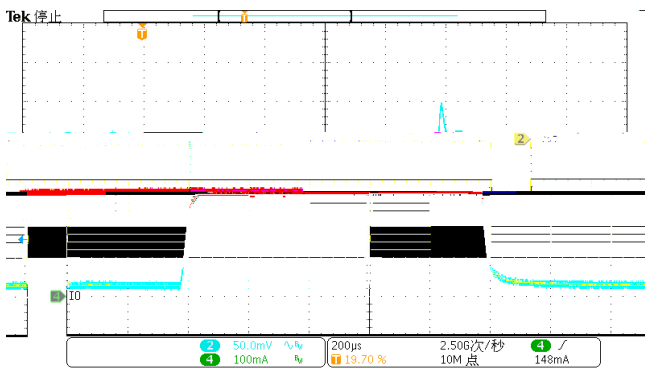

- +
% - / - &

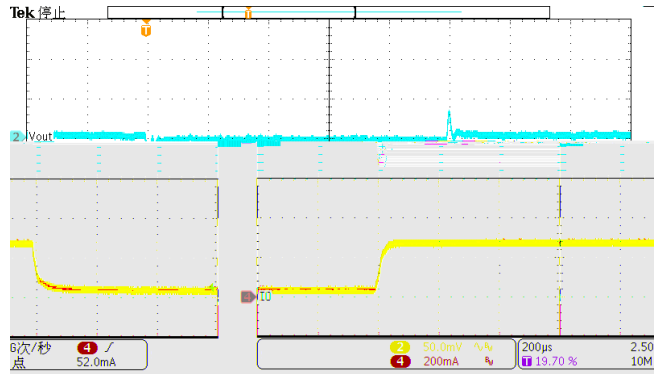

. +
% - / - & 0-0

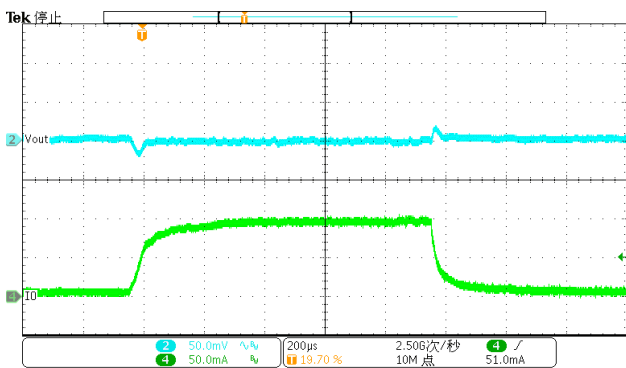

/ +
% . - - &

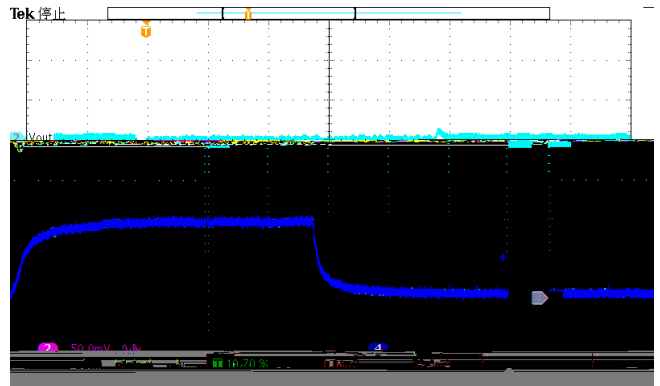

0 +
% . - - &) 0-0

(.)

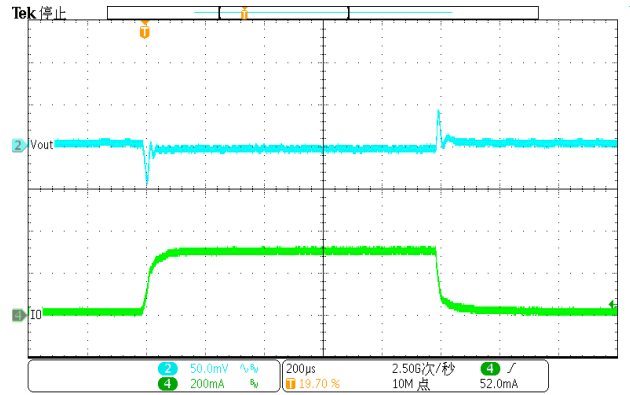
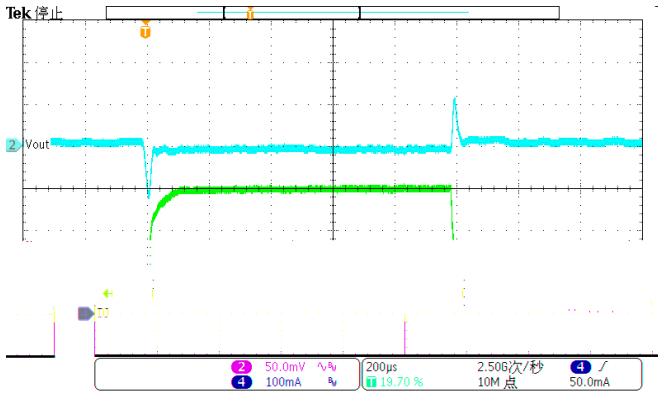

1+

+

% 0-- &)

% 0-- &) 0-0

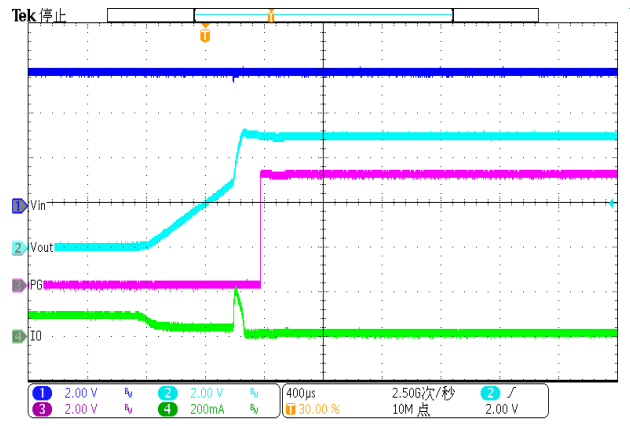
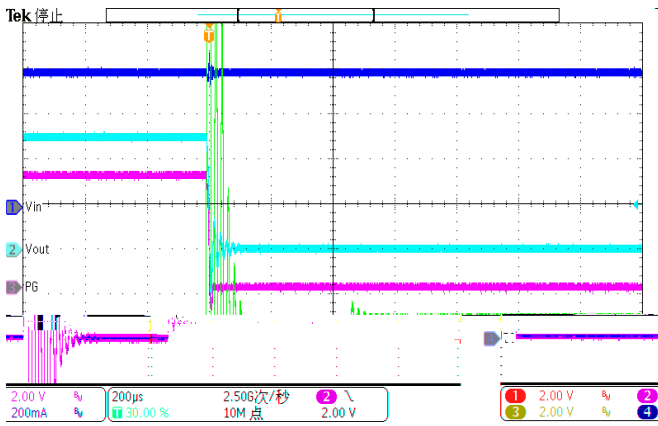

+

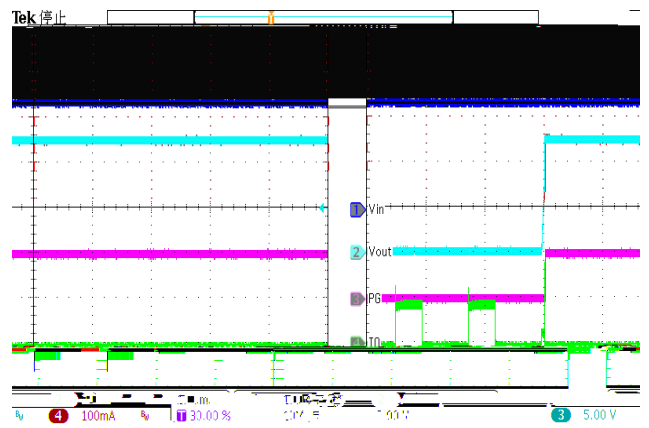
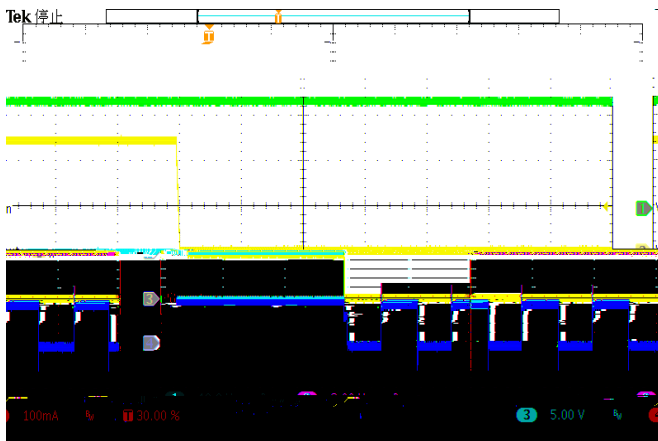

+

+

- 1.
- 2.
- 3.
- 4.
- 5.

) .1-0) +
) -+ + +
) + + +
))
 +) .-
 +

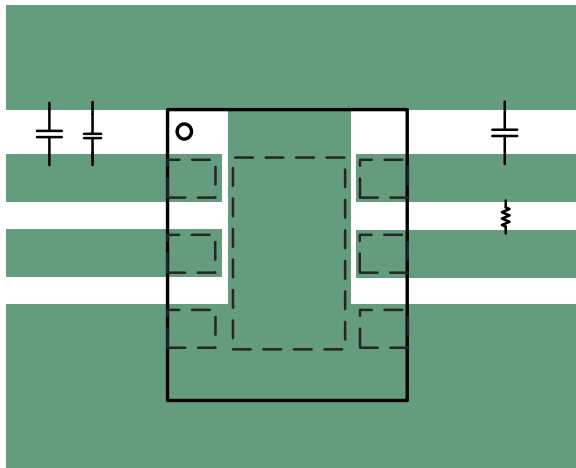

-+

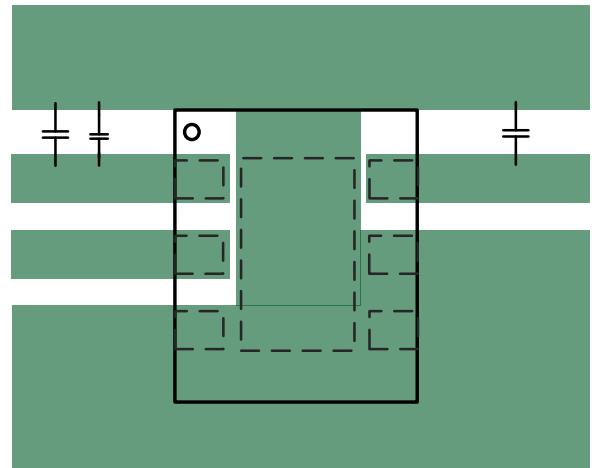

.+

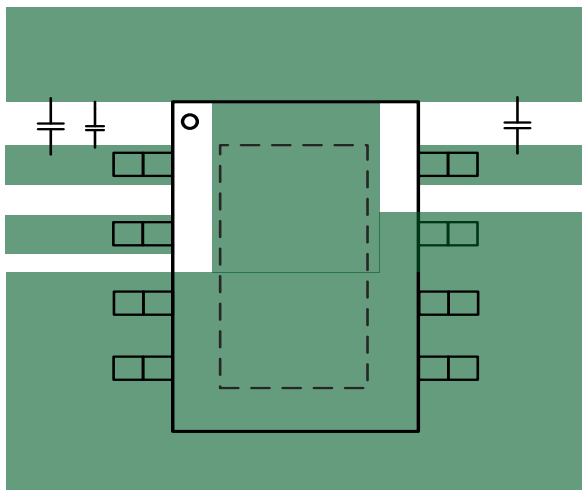

/+

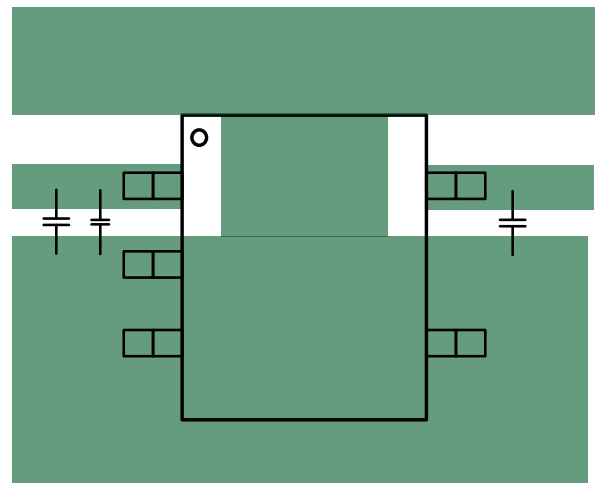

0+

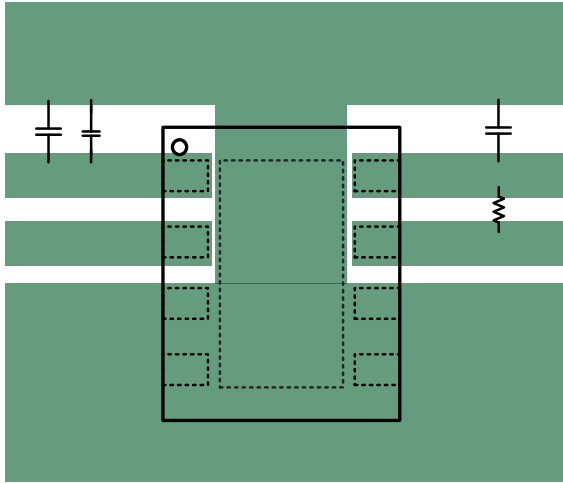

1+

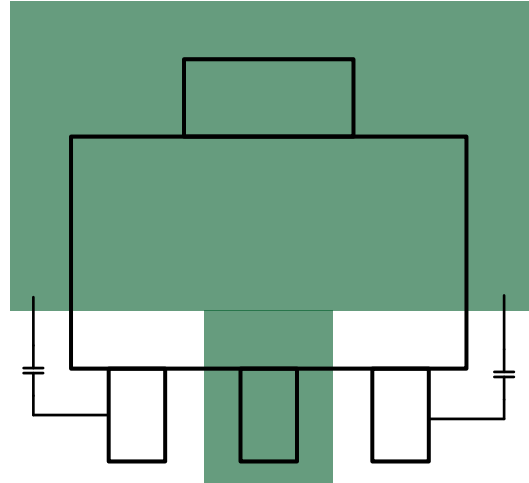

+

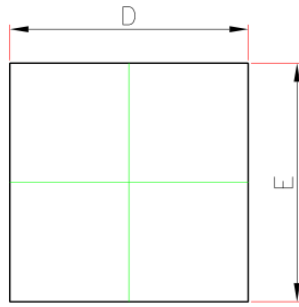

TOP VIEW

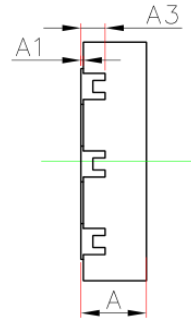

SIDE VIEW

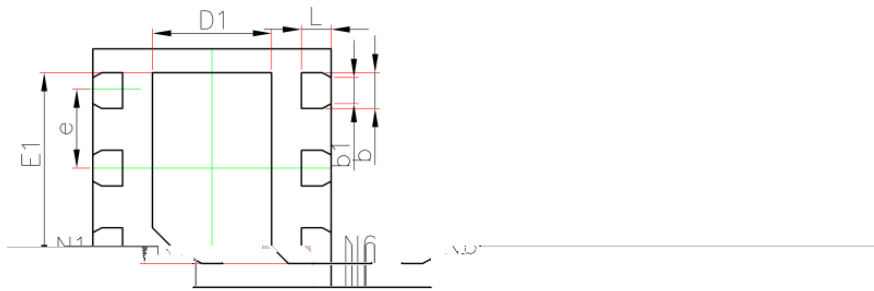

BOTTOM VIEW

//

	+	+	+	+
	- + - -	- + - -	- + /	- + 0.
.	- + - -	- + -	- + - -	- + - /
0	- + - 0		- + -	+
.	. + - -	/ + - -	- +	- + 0
.	. + - -	/ + - -	- +	- + 0
.	- + - -	. + - -	- + 0	- + 10
.	. + - -	. + - -	- +	- +
.	- + - -	- 0 -	- + . -	- + . 1
.	- + / -	+	- + -	+
.	- + -	+	- + /	+
.	- + 1	- 0 /	- + -	- + . 0

- 1.
- 2.
- 3.
- 4.
- 5.
- 6.



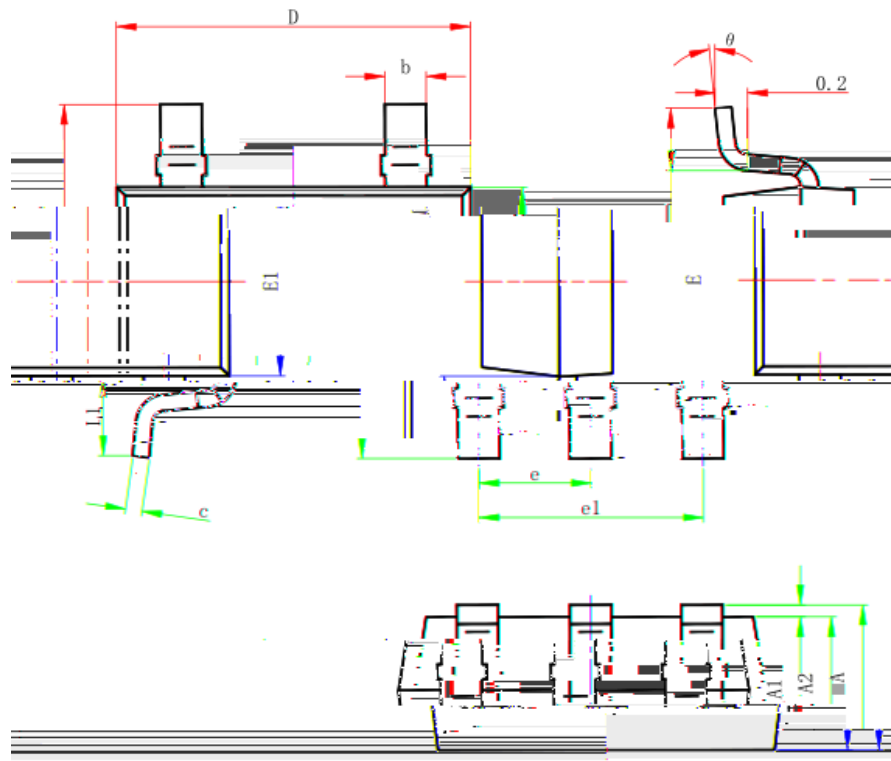

/0

	+	+	+	+
.	.+ -	.# -	-.+1.	-.+1
.	-.+--	-.+--	-.+--	-.+ -1
/	.+ -	.+ -	-.+1.	-.+1
.	-θ--	-.+--	-.+./	-.+/-
.	-.+--	-.+--	-.+ -1	-.+ -
.	/+/-	0+/-	-.+..	-.+.
.	.+--	.+--	-.+.	-.+.
.	/+ -	/+ -	-.+ -1	-.+.
.	-.+ - % &		-.+0 % &	
.	.+--	/+--	-.+.	-.+.
.	-θ--	-.+--	-.+./	-.+ /1
.	-.+--		-.+ /1	
.	-		-	

1. // - +
2. +
3. +
4. +
5. +
6. +

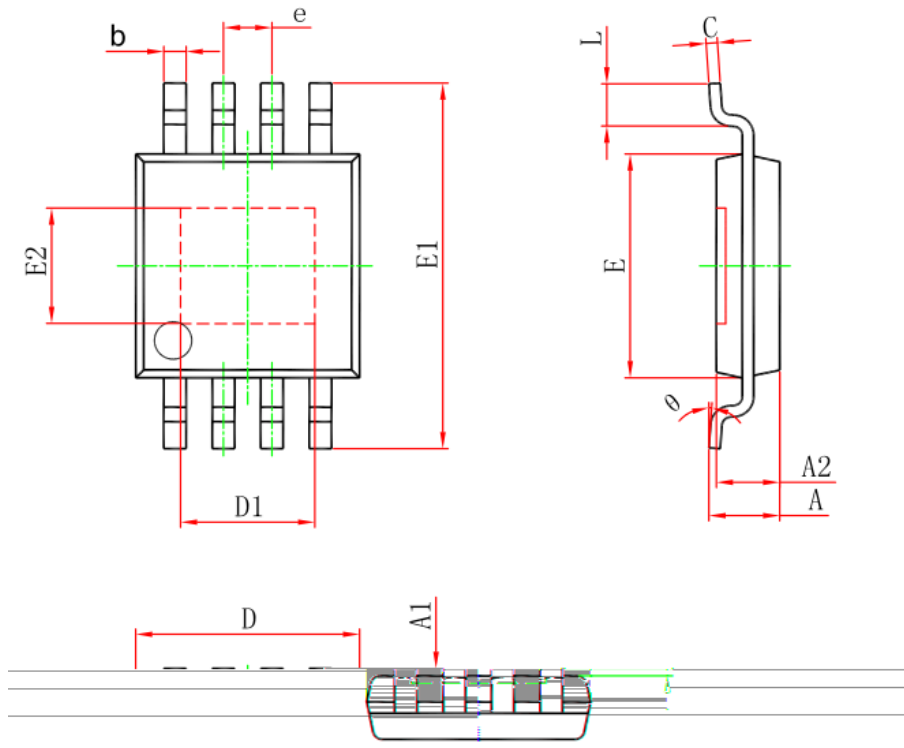

0 0

	+	+	+	+
	-+/-	.+--	-+0/	-+10
.	-+/-	-+ -	-+ .	-+ -
/	-+ -	-+ -	-+0-	-+0
	-# -	-# -	-+ . -	-+ .
	-+ -	-#0-	-+ -1	-+ -
	/+--	0+--	-+ .1	-+ //
.	.+--	.+--	-+	-+
	-+		-+ /	
	/+--	0+--	-+ .1	-+ //
.	1+ -	+ -	-+	-+
/	.# -	.+ -	-+	-+
	-#--	-+--	-+ .	-+0.
	-	-	-	

- 1.
- 2.
- 3.
- 4.
- 5.
- 6.

+ // - +

+ +

+ +

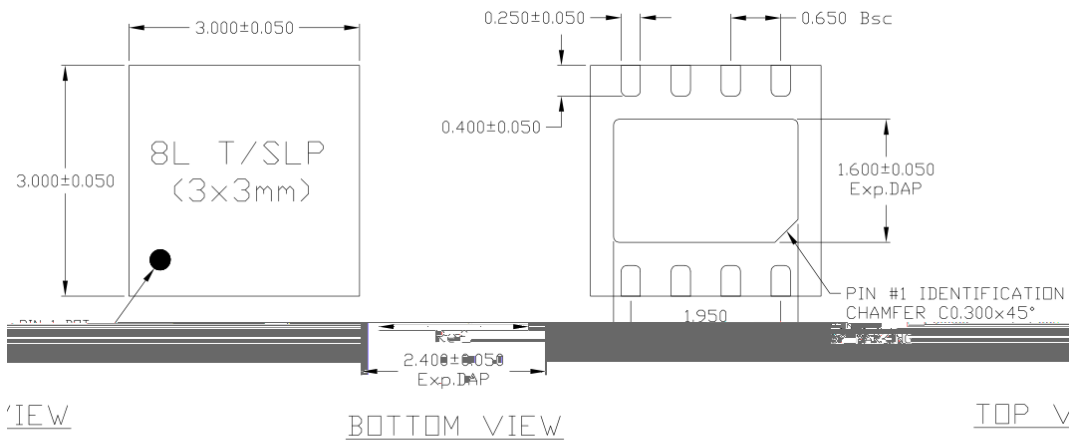

IE EXPOSE OUTLINE
SS:

J.P	SLP
00	0.900
50	0.650



NOTE:
1) TSLP AND SLP SHARE THE SAME
BUT WITH DIFFERENT THICKNESS:

△	MAX.	TSL
	MIN.	0.7



0 0

- 1.
- 2.
- 3.
- 4.
- 5.
- 6.

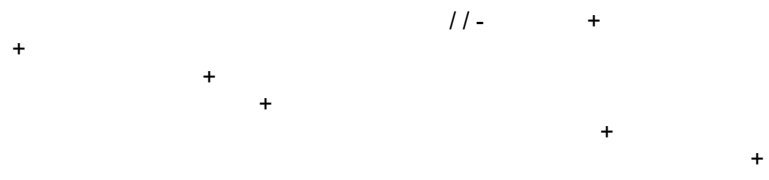

0-



1-1



.1-0

//01

	+	+	+	+
		+-		-+
	-+/-			

.1-0	/ /		0--
------	-----	--	-----

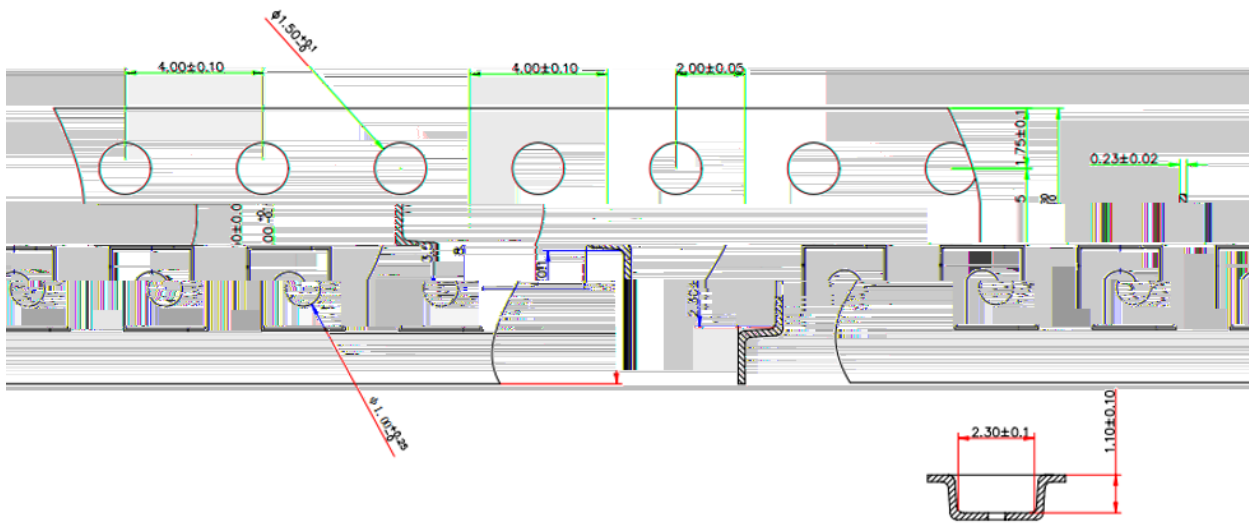
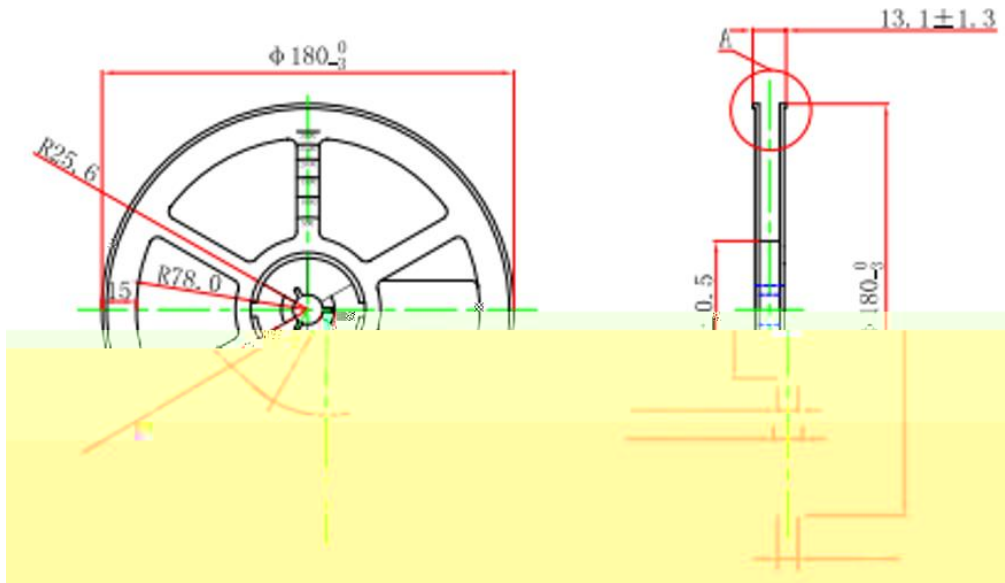

+

+

+

% &

.1-0	/0		0---
------	----	--	------

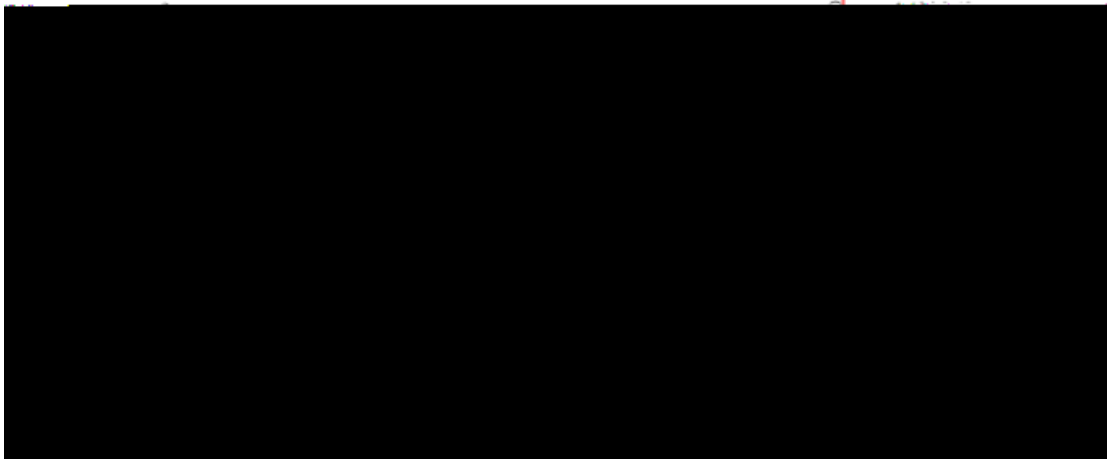
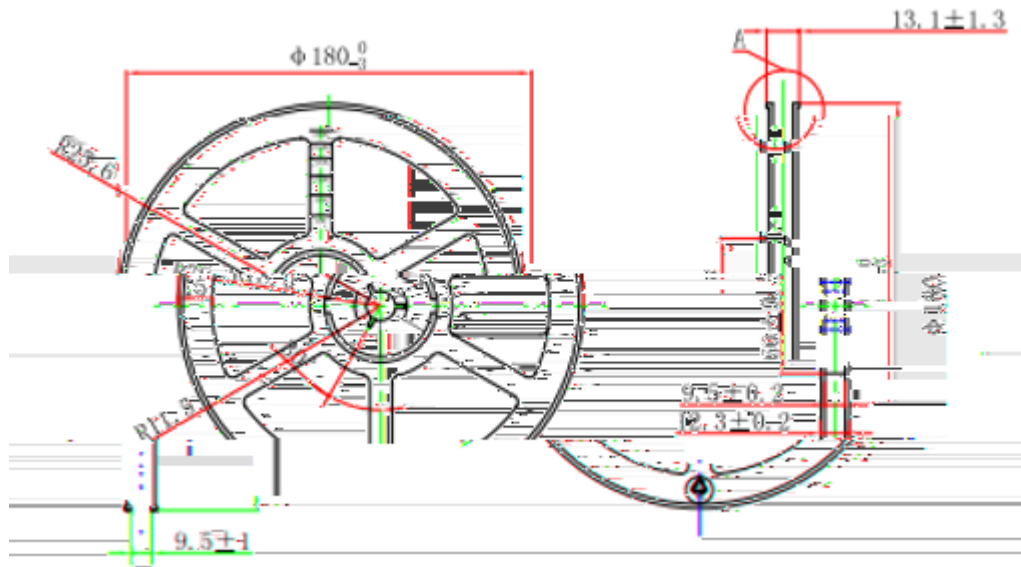

+ + % & +

.1-0	0 0	1---
------	-----	------

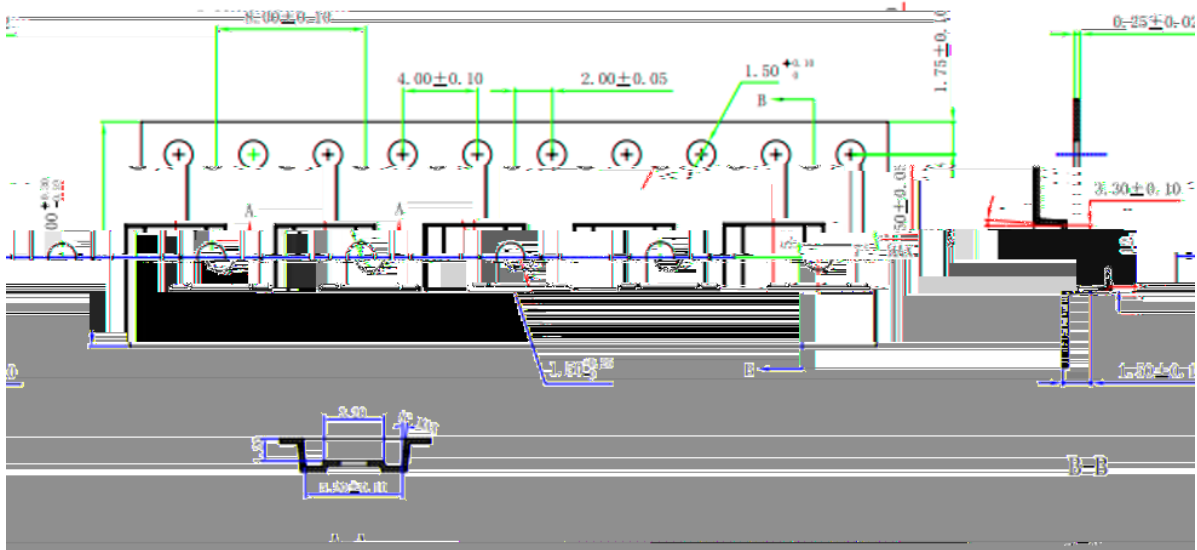
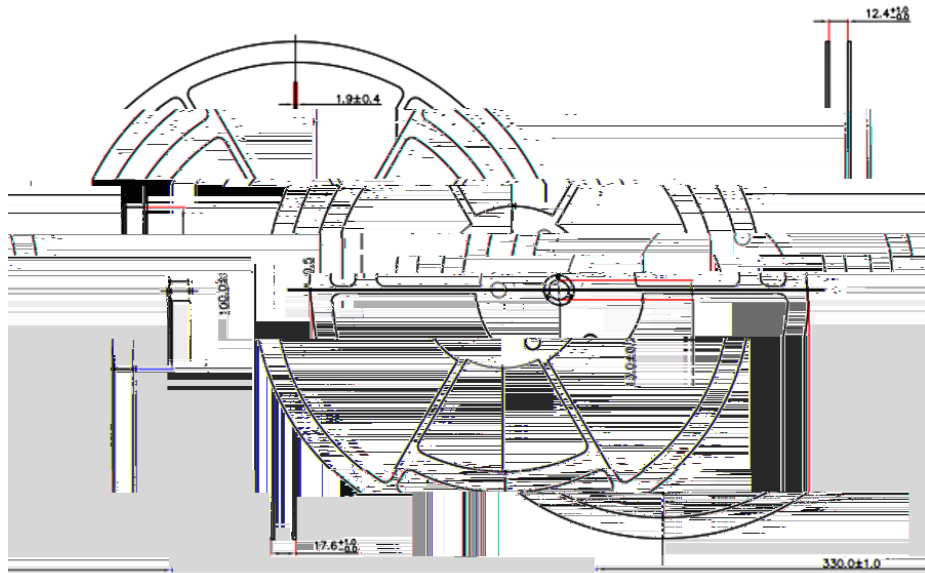

+ + % &

.1-0	0 0		---
------	-----	--	-----

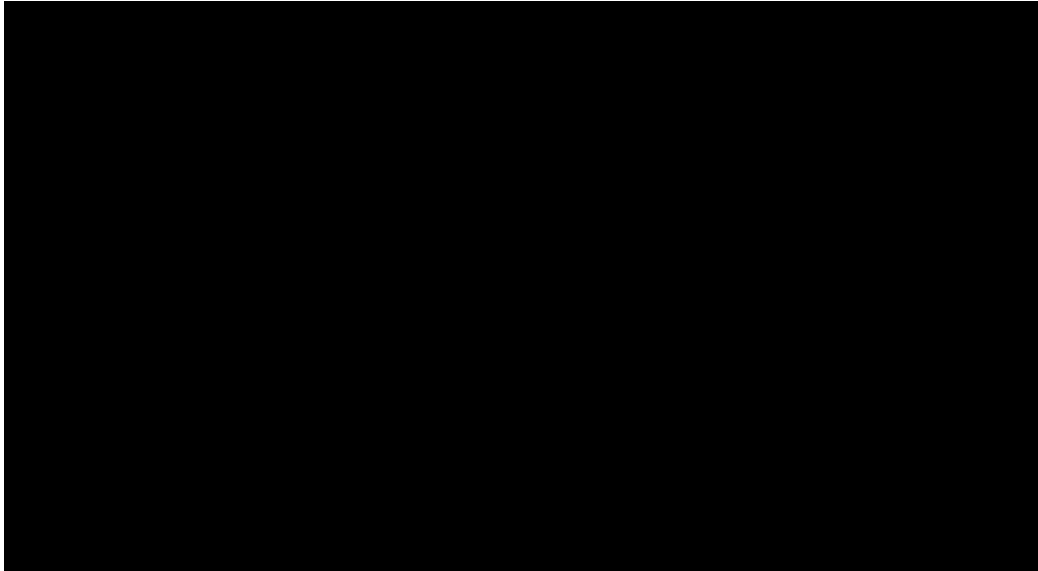
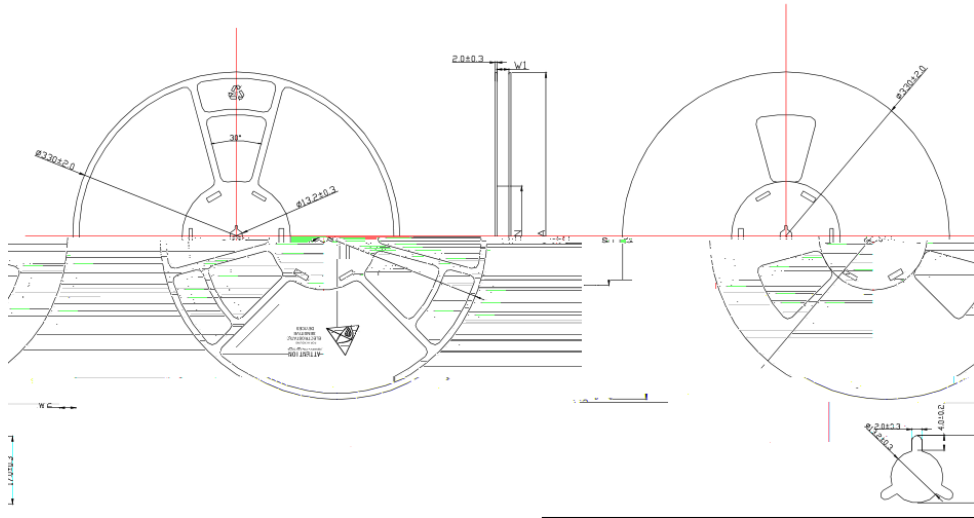

+

+

+

% &

